

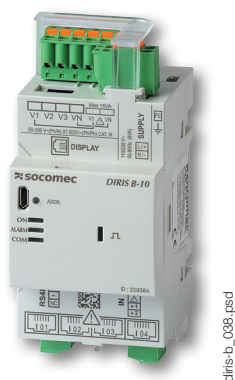

DIRIS B

Multifunction power monitoring devices

Measurement
& wireless metering



DIRIS B-10 / B-30
RS485

diris_b_038.psd



Configuration
with EasyConfig System.

Function

The DIRIS B is a power monitoring device in a modular format that communicates via RS485. The four RJ12 independent current inputs of the device allow it to manage several types and number of circuits: for example, 4 single-phase loads or 1 three-phase load + 1 single-phase load.

The DIRIS B is connected to current sensors (RJ12 connection) that are suitable for all types of installation: solid-core TE, split-core TR / ITR, and Rogowski TF current sensors.

Advantages

Plug & Play

A rapid RJ12 connection makes wiring easy and reliable to prevent wiring errors. Automatically addressing and configuring the product (communication address, load type, type and ratio of current sensor) simplifies implementation and saves time.

Better than revenue grade

- Class 0.2 for the meter alone according to ANSI C12.20.
- Class 0.5 according to IEC 61557-12 from 2 to 120% of nominal current for the global measurement chain (associated with TE/ITR/TF current sensors).

Bi-Directional Metering

DIRIS Digiware measures the flow of electricity in both directions.

Multi-circuit

- Four current measurement inputs allow you to configure multiple circuits in order to optimize the number of measurement devices per installation.

Communication

- The DIRIS B can be connected to:
 - a remote DIRIS D-30 screen for displaying measurement and metering data.
 - DIRIS Digiware M-50/M-70 gateways for centralization and communication of data via Ethernet. DIRIS Digiware M-70 embeds WEBVIEW-M, a webserver for remote visualization of measurement data.
 - optional digital or analog input/output modules, as well as temperature input modules can also be connected.

The solution for

- > Industry
- > Building
- > Infrastructure



Strong points

- > Plug & Play
- > Revenue grade accuracy ANSI C12.20
- > Multi-circuit
- > Communication

Integrated technologies



For more information see our website
www.socomec.us

Conformity to standards

- > UL 61010-1, CSA-C22.2 No. 51010-1, Guide PICQ, File E257746





- > IEC 61557-12

- > ISO 14025

- > CEC Compliant



Application	Local metering	Local analysis
		
DIRIS B	B-10 RS485	B-30 RS485
Number of current inputs	4	4
Metering		
± kWh, ± kvarh, kVAh	•	•
Load curves		•
Multi-tariff (demand)	•	•
Multi-measurement		
U12, U23, U31, V1, V2, V3, f	•	•
U system, V system	•	•
I1, I2, I3, In, ΣP, ΣQ, ΣS, ΣPF	•	•
P, Q, S, PF per phase	•	•
Predictive power	•	•
Ph/N unbalance	•	•
Ph/Ph unbalance	•	•
Current unbalance (Inba, Idir, linv, Ihom, Inb)	•	•
Phi, cos Phi, tan Phi	•	•
Power quality analysis		
THDv1, THDv2, THDv3, THDu12, THDu23, THDu31	•	•
THDi1, THDi2, THDi3, THDin	•	•
Individual harmonics U & V (up to 63 rd)		•
Individual harmonics I (up to 63 rd)		•
Crest factor I1, I2, I3, In		•
Crest factor V1, V2, V3, U12, U23, U31		•
Voltage sags, interruptions, swells (EN 50160)		•
Overcurrents		•
Alarms		
On threshold		•
Inputs/outputs	•	•
History of average values		
45 days (max)		•
Communication		
RS485 Modbus	•	•
2 inputs (status/pulse)	•	•

Accessories

DIRIS B sealing cover

- Prevents access to the cabling of the monitoring device.

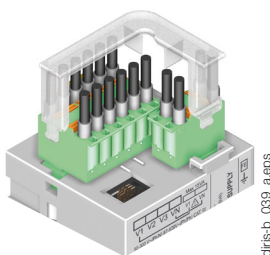

USB configuration cable (6.56 ft / 2 m)

- Advanced configuration of DIRIS B gateways can be achieved using the EASY CONFIG System via Ethernet or direct USB connection.

DIRIS B

Multifunction power monitoring devices

DIRIS D-30 display

DIRIS D-30

Connection



Optional modules

DIRIS O

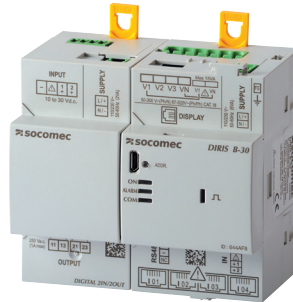
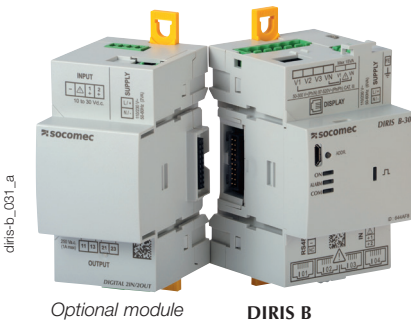

Optional modules (4 max.)*

- Digital inputs/outputs
- Analog inputs/outputs
- Temperature inputs

* maximum 4 optional modules with maximum 1 temperature module.



DIRIS O-iod

- 2 digital inputs centralizes the metering pulses or the input status changes of the auxiliary contacts.
- 2 digital outputs can be connected to configurable alarms warning of exceeded thresholds (power, current, etc.) or can be piloted remotely.



DIRIS O-ioa

- 2 inputs (4-20 mA) centralize analog sensors (pressure, humidity, temperature, etc.)
- 2 outputs (4-20 mA) report the measurements (power, currents, etc.) to PLCs.



DIRIS O-it

- 3 temperature inputs to be connected to PT100 or PT1000 sensors.
- Ambient air temperature:

DIRIS B terminals

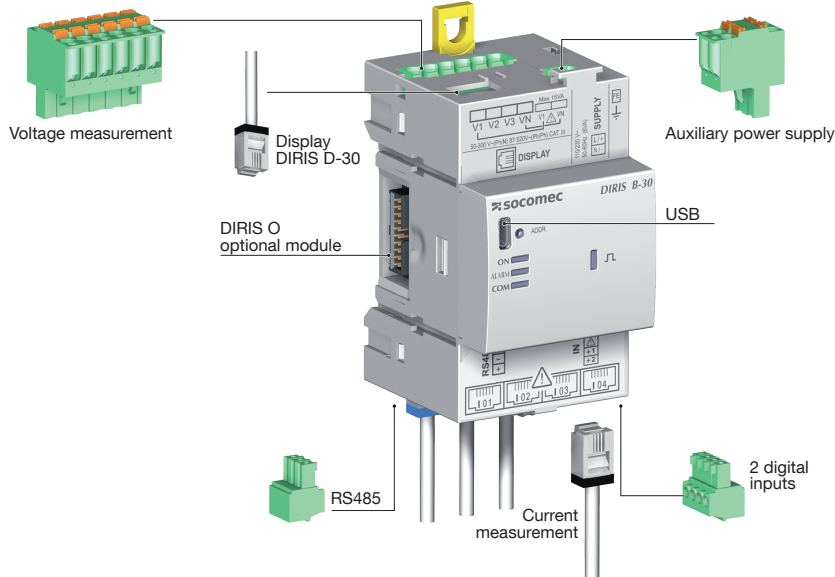

diris-d_027_b_1_gb_cat

Current measurement

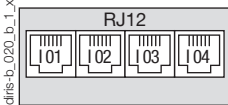

Voltage measurement and auxiliary power supply

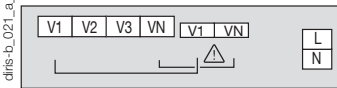

2 inputs supplied by the product

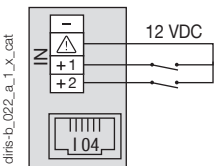

diris-b_022_a_1_x_cat

Self supply

Easy connection of the power supply from the measurement terminal (specific terminals)

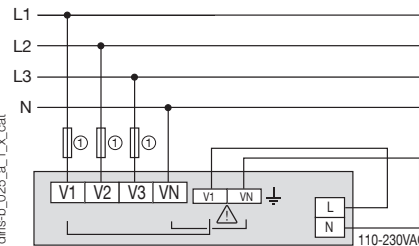

1. Fuses 0.5 A class CC.

diris-b_025_a_1_x_cat

Separate power supply

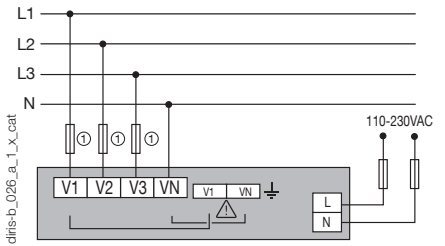

1. Fuses 0.5 A class CC.

diris-b_026_a_1_x_cat

2 inputs with external power supply

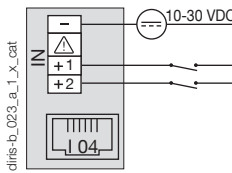

diris-b_023_a_1_x_cat

RS485

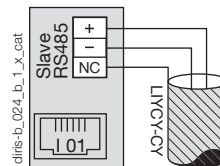

diris-b_024_b_1_x_cat

RJ9 for DIRIS D-30 (self-supply and data)

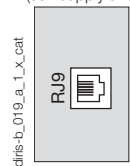

diris-b_019_a_1_x_cat

Terminals of optional DIRIS O modules

Optional module power supply

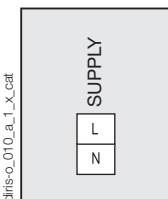

diris-o_010_a_1_x_cat

DIRIS O-iob

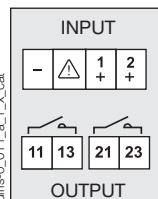

diris-o_011_a_1_x_cat

DIRIS O-ioa

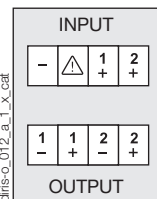

diris-o_012_a_1_x_cat

DIRIS O-it

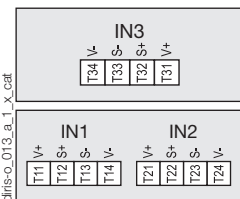

diris-o_013_a_1_x_cat

DIRIS B

Multifunction power monitoring devices

Connections

Associated current sensors

Various types of current sensors can be connected to the DIRIS B: Solid-core TE, split-core TR/iTR, flexible TF current sensors. This range of sensors can be adapted to all types of new or existing installations. A rapid RJ12 connection makes wiring easy and reliable and prevents wiring errors. The DIRIS B automatically recognizes the type of sensor used and its current rating. This guarantees the overall accuracy of the DIRIS B + current sensor measurement chain.
 For more information: see "current sensor" pages.

TE solid-core current sensors

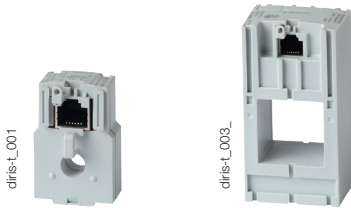

TR/iTR split-core current sensors TF flexible current sensors

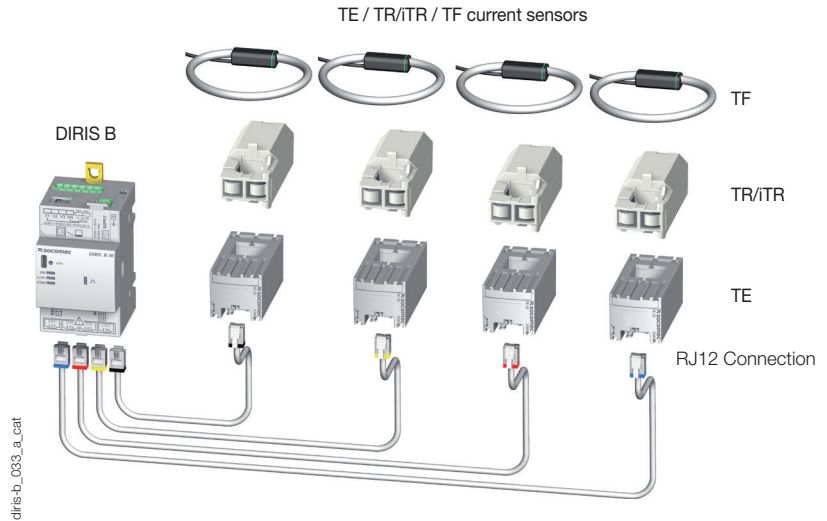
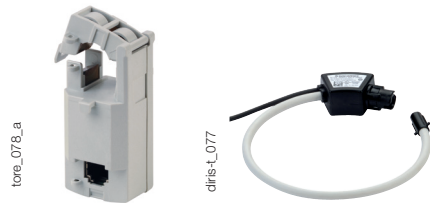

Network and connection examples

Three phase + neutral

3P+N - 4CTs (measurement for 1 three-phase load + Neutral)

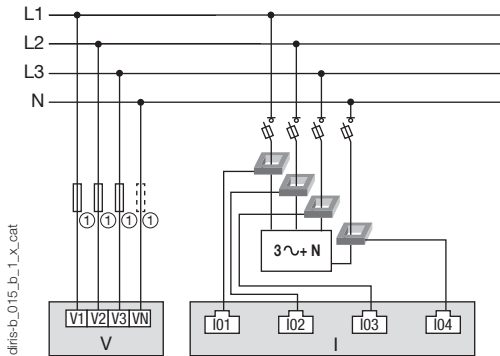

Three-phase

3P - 2CTs (2 three-phase loads without neutral)

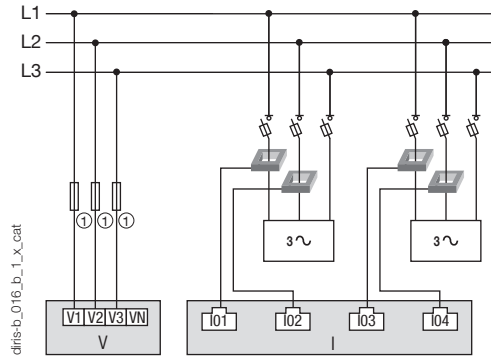

Three-phase

3P+N - 3CTs & 1P+N - 1CT (1 three-phase load & 1 single-phase load)

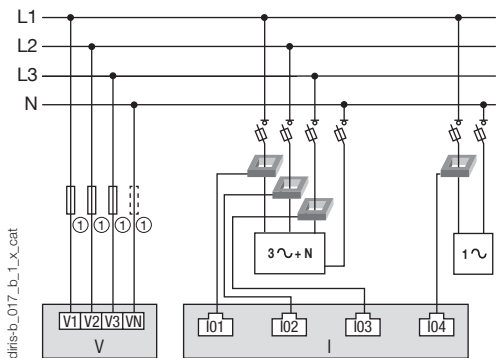

Single-phase

1P+N-1CT (4 single-phase loads)

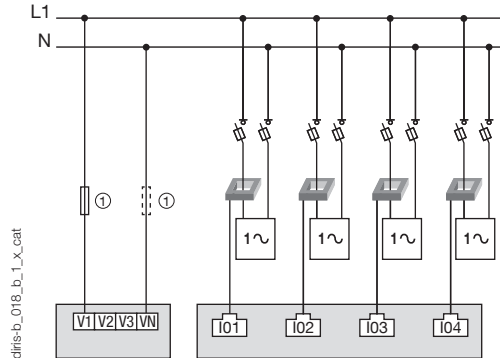

1. Fuses 0.5 A class CC.

In case of self-supply, a fuse must be added on the neutral.



Dimensions (in/mm)

DIRIS B

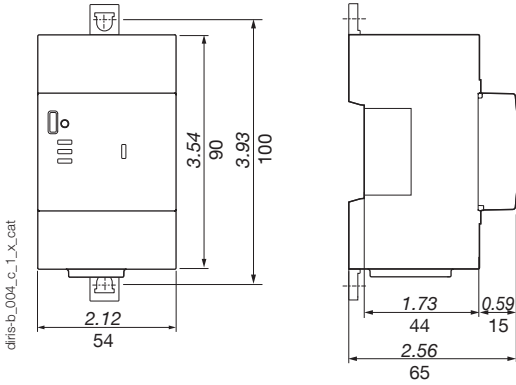

DIRIS O optional modules

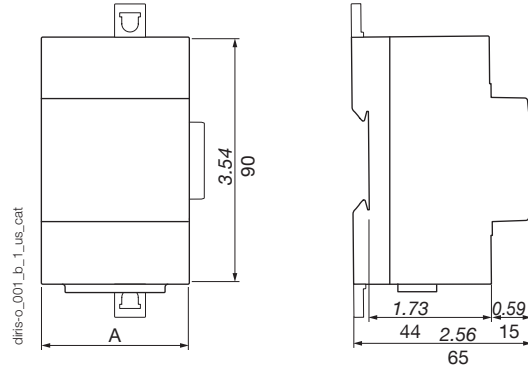

DIRIS O optional modules	A (in / mm)
DIRIS O-iod - DIRIS O-ioa - DIRIS O-it	1.77 / 45

DIRIS D-30

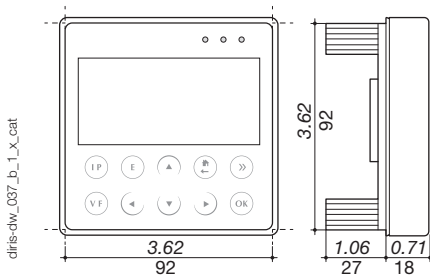

Communication architecture

Example of communication architecture with DIRIS Digiware M-70 gateway and WEBVIEW-M embedded web server.

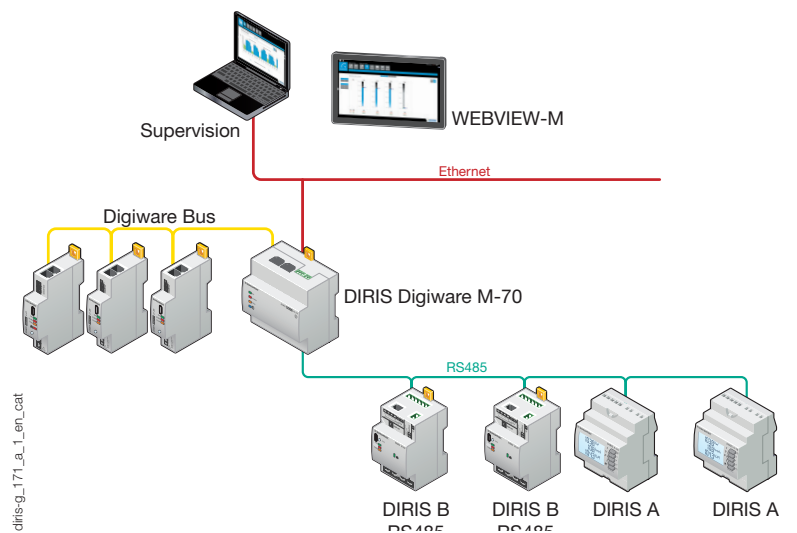

DIRIS B

Multifunction power monitoring devices

DIRIS B characteristics

Electrical characteristics

Auxiliary power supply	
AC voltage	110-230 VAC ±15 % (Ph/N ou Ph/Ph) Cat III
Frequency	50/60 Hz
Consumption	< 2 VA without display < 6 VA with display
Connection	Removable spring-cage terminal, 2 x 2 positions, AWG 10 ... 24 / 0.5 ... 2.5 mm ² solid cable or AWG 15 ... 30 / 0.25 ... 1.5 mm ² stranded cable with ferrule

Measurement characteristics

Energy and power measurement	
Accuracy	Class 0.2 DIRIS B alone
Active energy and active power	Class 0.5 with TE, ITR or TF current sensors Class 1 with TR current sensors
Reactive energy accuracy	Class 2 with TE, TR/ITR or TF current sensors

Power factor measurement	
Accuracy	Class 0.5 with TE, ITR or TF current sensors Class 1 with TR current sensors

Voltage measurement	
Network characteristics measured	50-300 VAC (Ph/N) - 87-520 VAC (Ph/Ph) - CAT III
Frequency range	45 ... 65 Hz
Frequency accuracy	Class 0.02
Network type	Single-phase / Two-phase / Two-phase with neutral / Three-phase / Three-phase with neutral
Measurement by voltage transformer	Primary: 400 000 VAC Secondary: 60, 100, 110, 173, 190 VAC
Input consumption	≤ 0.1 VA
Permanent overload	300 VAC Ph/N
Voltage measurement accuracy	Class 0.2
Connection	Removable spring-cage terminal, 2 x 6 positions, AWG 10 ... 24 / 0.5 ... 2.5 mm ² solid cable or AWG 15 ... 30 / 0.25 ... 1.5 mm ² stranded cable with ferrule

Current measurement	
Number of current inputs	4
Associated current sensors	Solid TE, split-core TR/ITR, flexible TF current sensors
Accuracy	Class 0.2 DIRIS B alone Class 0.5 with TE, ITR or TF current sensors Class 1 with TR current sensors
Connection	RJ12 connectors with specific SOCOMEC cable

Input characteristics

Number	2
Type / Power supply	Optocoupler internal polarisation (12 VDC ± 10 %) or external polarisation (10-30 VDC ± 10%)
Input function	Logic status, pulse meter or synchronization pulse status (input 1)

Communication characteristics

DIRIS B RS485	
Link	RS485
Connection type	2 ... 3 half duplex wires
Protocol	Modbus RTU
Speed	1200 ... 115200 bauds
USB	DIRIS B RS485 configuration

Environment characteristics

Operating temperature	+14 ... +158 °F / -10 ... +70 °C
Storage temperature	-13 ... +185 °F / -25 ... +85 °C
Operating humidity	131 °F / 55 °C / 97% relative humidity
Operating altitude	6560 feet / 2000 m
Vibration	1G from 10 to 100Hz

DIRIS D-30 display characteristics

Mechanical characteristics	
Screen type	Capacitive touch-screen technology, 10 keys
Screen resolution	350 x 160 pixels
Single product connection	
RJ9	Self-supply and data
Micro-USB	Updating
Degree of protection	IP65 (front face)
Environment	
Storage temperature (°C)	-4 ... +158 °F / -20 ... +70 °C
Operating temperature (°C)	-4 ... +158 °F / -20 ... +70 °C
Humidity	95 % at 104 °F / 40 °C
Installation category	CAT III
Degree of pollution	2

DIRIS O optional modules characteristics

Power supply ⁽¹⁾	
AC voltage	110-230 VAC ±15 %
Frequency	50/60 Hz

(1) No power supply on DIRIS O-it.

DIRIS O-iod - 2 digital inputs/2 digital outputs	
Number of inputs	2 per optional modules - max. 4 optional modules
Type	Optocoupler internal polarisation (12 VDC ± 10 %) or external polarisation (10-30 VDC ± 10%)
Function	Logic status or pulse meter
Number of outputs	2 per optional modules - max. 4 optional modules
Type	Relay / 230VAC ±15 % - 1 A
Function	Configurable alarm (current, power,...) on threshold overruns or remote controlled status
Inputs/Outputs connection	Removable screw terminal, 4 positions, AWG 15 ... 35 / 0.14 to 1.5 mm ² stranded or solid cable

DIRIS O-ioa - 2 analog inputs/2 analog outputs	
Number of inputs	2 per optional modules - max. 4 optional modules
Type	4-20 mA
Function	Connection of analog sensors (pressure, humidity, temperature...)
Number of outputs	2 per optional modules - max. 4 optional modules
Type	4-20 mA
Function	Transmission of measurement image (current, power...) to PLCs

DIRIS O-it - 3 temperature inputs	
Number of inputs	3 external inputs + 1 measurement for ambient temperature
Dynamic	-4 ... 302 °F / -20 ... 150 °C
Type	PT100 or PT1000
Function inputs 1, 2 and 3	Temperature measurement

References

DIRIS B monitoring devices		Reference
DIRIS B-10	RS485 - Modbus - 230 VAC	4829 0010
DIRIS B-30	RS485 - Modbus - 230 VAC	4829 0000
DIRIS O optional modules		Reference
DIRIS O-iod	2 digital inputs / 2 digital outputs	4829 0030
DIRIS O-ioa	2 analog inputs/2 analog outputs 4-20 mA	4829 0031
DIRIS O-it	3 temperature inputs PT 100 / PT 1000	4829 0032
Accessories		Reference
DIRIS D-30 - Single-point display		4829 0200
RJ9 cable for DIRIS D-30 display - 4.92 ft / 1.5 m		4829 0280
RJ9 cable for DIRIS D-30 display - 9.84 ft / 3 m		4829 0281
DIRIS B sealing cover for I/O terminals		4829 0049
USB configuration cable		4829 0050